

## MOTORE TORQUE - MK-CI 450-100 WA

Specifiche Motore	Simbolo	Unità	
Numero di poli	P		88
Coppia di Picco	T <sub>pk</sub>	Nm	2439
Coppia Continuativa (Raff. Liquido Dt100)	T <sub>wc</sub>	Nm	1355
Coppia Continuativa (Raff. Aria Dt100)	T <sub>ac</sub>	Nm	570
Coppia di Stallo (Raff. Liquido)	T <sub>wsc</sub>	Nm	1070
Coppia di Stallo (Raff. Aria)	T <sub>sac</sub>	Nm	437
Ripple di Coppia (Cogging)	Tr	Nm	14
Potenza Dissipata (Raff. Liquido)	P <sub>wc</sub>	Kw	6,2
Potenza Dissipata (Raff. Aria)	P <sub>ac</sub>	Kw	1,1
Resistenza Termica (Raff. Liquido)	R <sub>thWc</sub>	Kw	0,02
Resistenza Termica (Raff. Aria)	R <sub>thAc</sub>	Kw	0,1
Costante di Coppia	K <sub>t</sub>	Nm/a	52,12
Costante di tensione	K <sub>e</sub>	V/1000 Rpm	3212
Massima Velocità a I <sub>pk</sub> a 600 Vdc	N <sub>pk</sub>	rpm	20
Massima Velocità a I <sub>wc</sub> a 600 Vdc	N <sub>wc</sub>	rpm	80
Massima Velocità a I <sub>ac</sub> a 600 Vdc	N <sub>ac</sub>	rpm	110
Resistenza (Fase-Fase)	R <sub>20</sub>	Ω	4
Induttanza (Fase-Fase)	L	mh	26,7
Corrente di Picco	I <sub>pk</sub>	Arms	68
Corrente continuativa (Raff. Liquido Dt100)	I <sub>wc</sub>	Arms	27,3
Corrente Continuativa (Raff. Aria Dt100)	I <sub>ac</sub>	Arms	11,3
Corrente di Stallo 0 Rpm (Raff. Liquido)	I <sub>wsc</sub>	Arms	20,8
Corrente di Stallo 0 Rpm (Raff. Aria)	I <sub>sac</sub>	Arms	8,6
Massima temperatura di avvolgimento		°C	130
Altezza del Rotore		mm	100
Altezza dello statore		mm	160
Diametro esterno statore		mm	485

### Diagramma di coppia

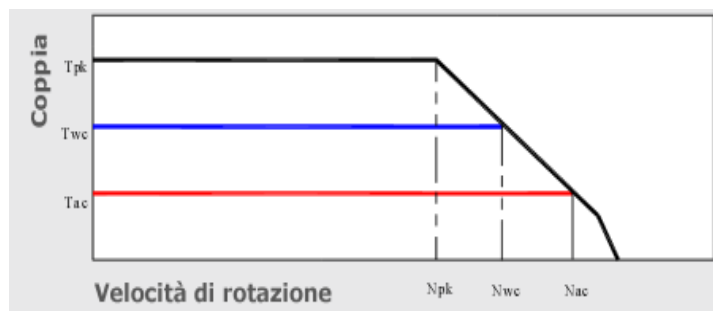

## MOTORE TORQUE - MK-CI 450-100 WB

Specifiche Motore	Simbolo	Unità	
Numero di poli	P		88
Coppia di Picco	T <sub>pk</sub>	Nm	2445
Coppia Continuativa (Raff. Liquido Dt100)	T <sub>wc</sub>	Nm	1355
Coppia Continuativa (Raff. Aria Dt100)	T <sub>ac</sub>	Nm	570
Coppia di Stallo (Raff. Liquido)	T <sub>wsc</sub>	Nm	1070
Coppia di Stallo (Raff. Aria)	T <sub>sac</sub>	Nm	437
Ripple di Coppia (Cogging)	Tr	Nm	14
Potenza Dissipata (Raff. Liquido)	P <sub>wc</sub>	Kw	6,2
Potenza Dissipata (Raff. Aria)	P <sub>ac</sub>	Kw	1,1
Resistenza Termica (Raff. Liquido)	R <sub>thWc</sub>	Kw	0,02
Resistenza Termica (Raff. Aria)	R <sub>thAc</sub>	Kw	0,1
Costante di Coppia	K <sub>t</sub>	Nm/a	26,8
Costante di tensione	K <sub>e</sub>	V/1000 Rpm	1652
Massima Velocità a I <sub>pk</sub> a 600 Vdc	N <sub>pk</sub>	rpm	85
Massima Velocità a I <sub>wc</sub> a 600 Vdc	N <sub>wc</sub>	rpm	170
Massima Velocità a I <sub>ac</sub> a 600 Vdc	N <sub>ac</sub>	rpm	230
Resistenza (Fase-Fase)	R <sub>20</sub>	Ω	1
Induttanza (Fase-Fase)	L	mh	7
Corrente di Picco	I <sub>pk</sub>	Arms	131
Corrente continuativa (Raff. Liquido Dt100)	I <sub>wc</sub>	Arms	53
Corrente Continuativa (Raff. Aria Dt100)	I <sub>ac</sub>	Arms	22
Corrente di Stallo 0 Rpm (Raff. Liquido)	I <sub>wsc</sub>	Arms	40,5
Corrente di Stallo 0 Rpm (Raff. Aria)	I <sub>sac</sub>	Arms	16,8
Massima temperatura di avvolgimento		°C	130
Altezza del Rotore		mm	100
Altezza dello statore		mm	160
Diametro esterno statore		mm	485

### Diagramma di coppia

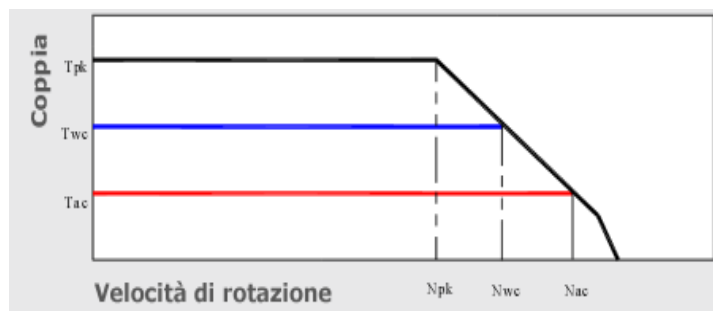

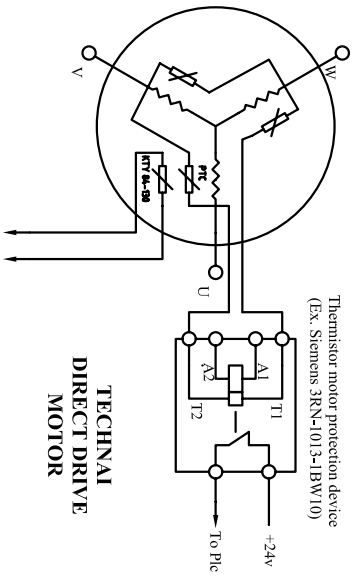
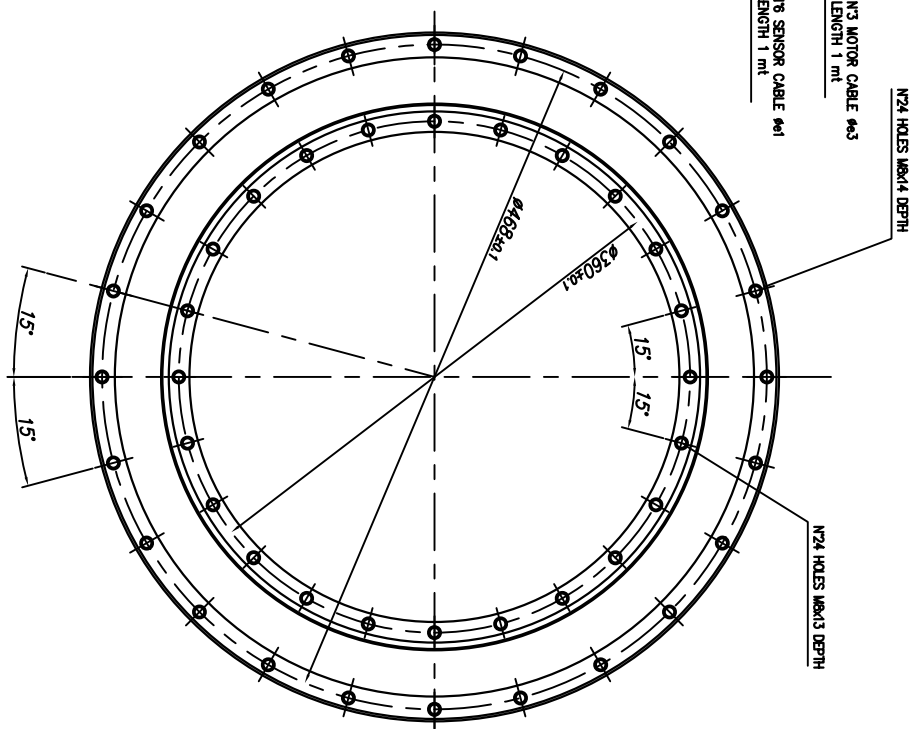
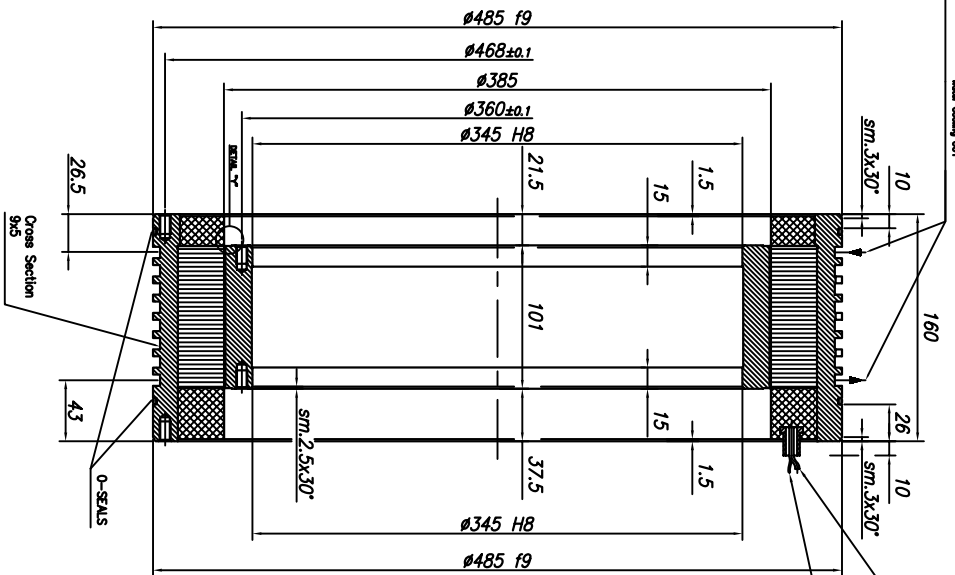
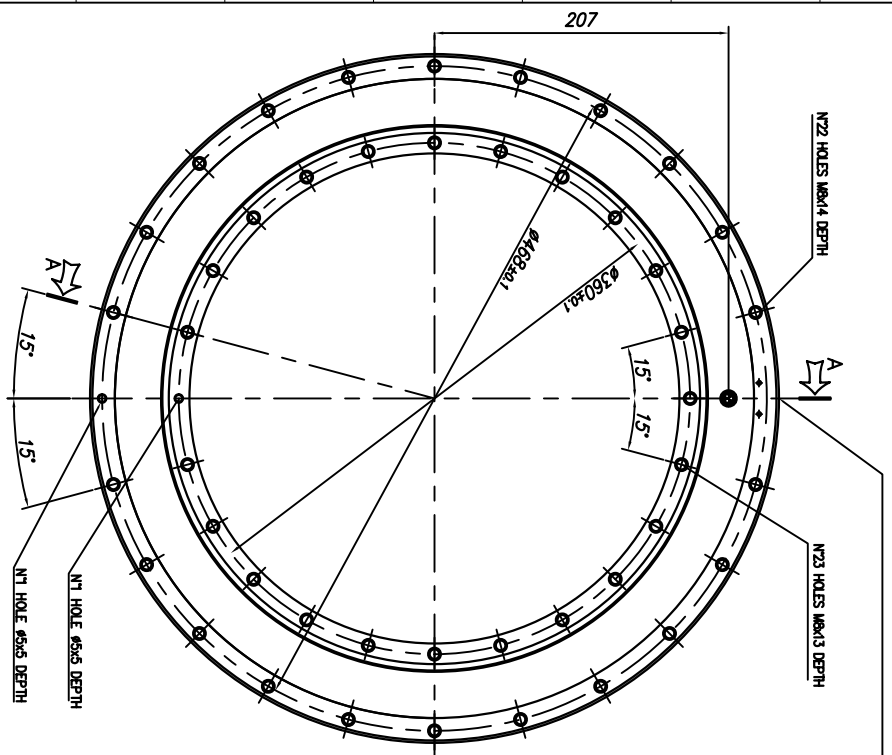

TECHNAI  
DIRECT DRIVE  
MOTOR

To Drive with KTY 84 input (Ex. Simodrive 611D(U) or multimeter with the appropriate rating

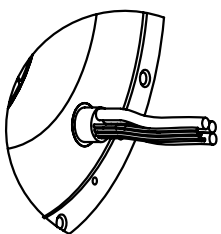

CABLE OUTPUT  
CONFIGURATION  
MF

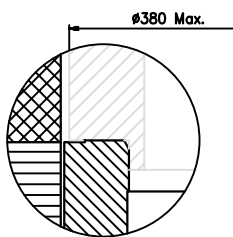

DETAIL "y-y"  
ROTOR INTERFACE TO  
CUSTOMER SHAFT

REV.	DATE	DESCRIPTION	BY	CHECKED
001	18.08.2009	GENERAL ASSEMBLY		
<b>TECHNAI</b> ROTOR-STATOR KIT MK-CI 450 MK-CI 450-100 MF SHEET 1 OF 1				

Proprietà esclusiva di TECHNAI Termi s.r.l. - Riproduzione e diffusione vietata, senza autorizzazione scritta.

SEZIONE "A-A"

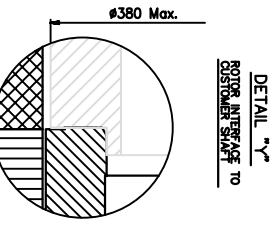
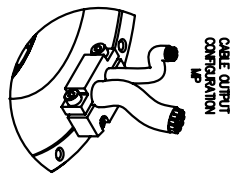
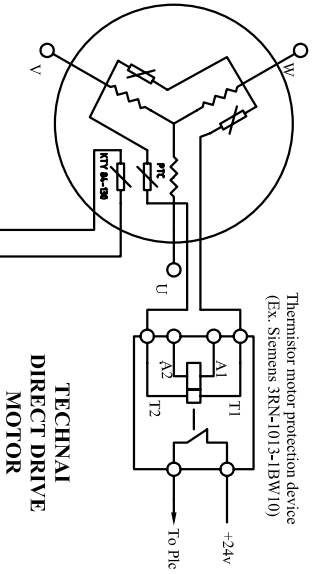
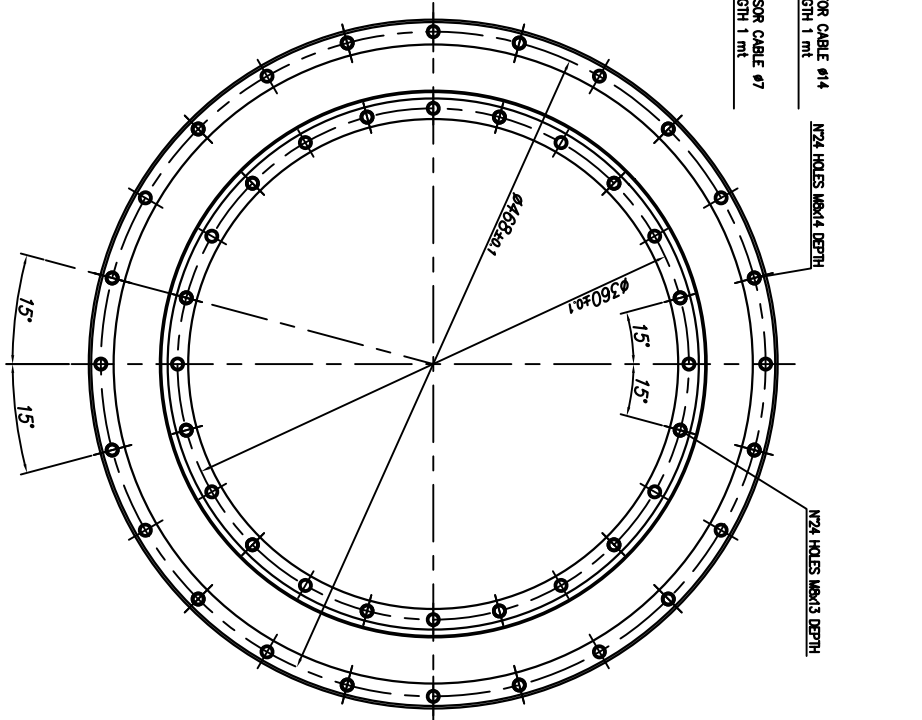
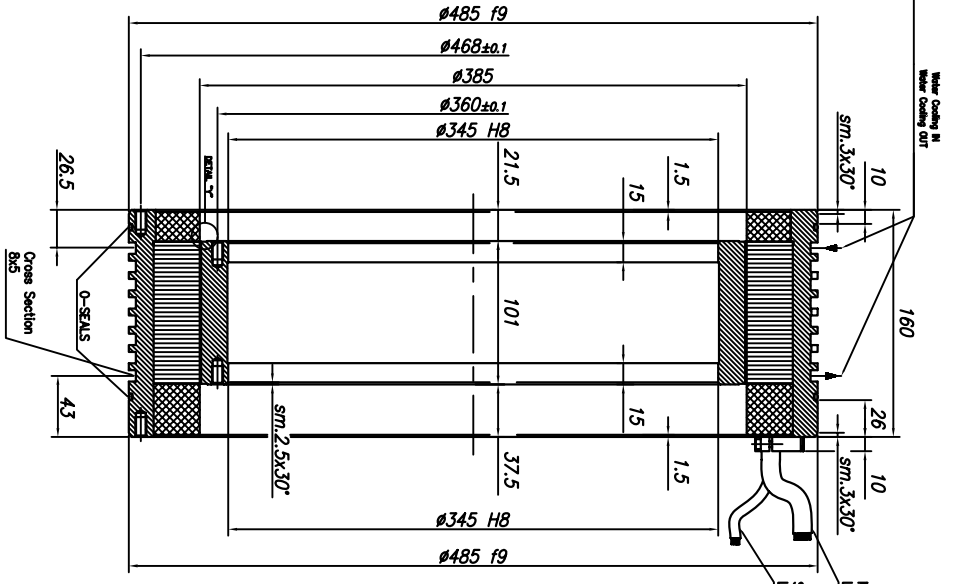
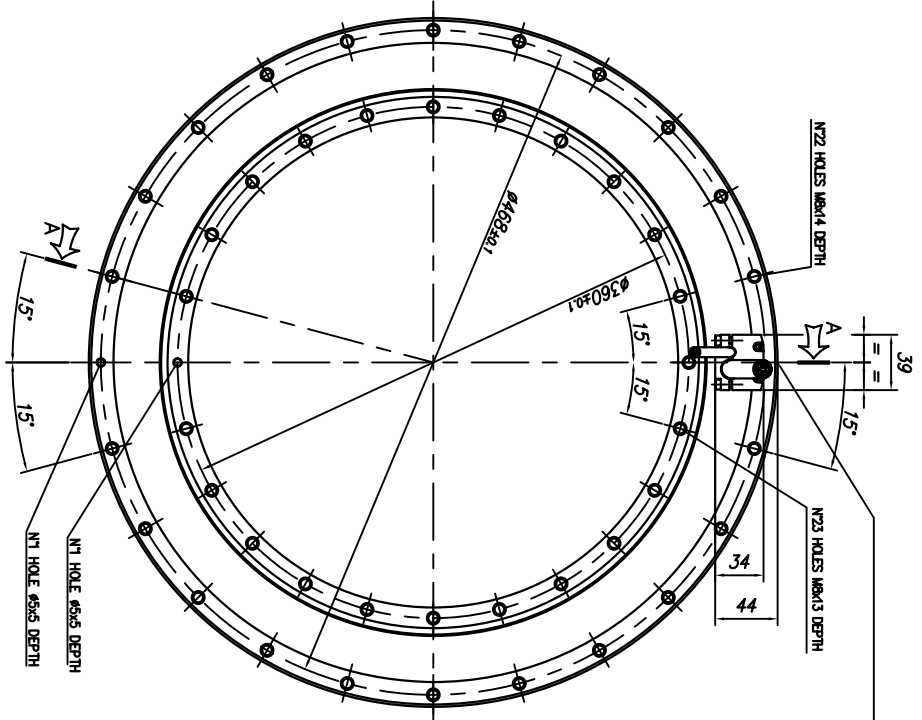

To Drive with KTY 84 input (Ex. Simodrive 611D/U) or multimeter with the appropriate rating

TECHNICAL  
DIRECT DRIVE  
MOTOR

NO. 0001	DATE	SCALE	SHEET NO. 01	TOTAL SHEETS 01
DESIGNED BY	DATE	SCALE	SHEET NO. 01	
CHECKED BY	DATE	SCALE	SHEET NO. 01	
APPROVED BY	DATE	SCALE	SHEET NO. 01	
<b>TECHNICAL</b>				
GENERAL ASSEMBLY				
ROTOR-STATOR KIT MK-CI 450				
MK-CI 450-100 MP				
SHEET 1 OF 1				